

CMP "R" Panel Trim

1. Stepped Ridge
2. Formed Ridge
3. Outside Corner
4. Gable Trim
5. Drip Trim
6. Inside Corner
7. Base Drip Angle
8. J-Channel
9. Valley
10. End Wall Trim
11. Side Wall Trim
12. Base Angle Stop
13. Transition Trim
14. Gambrel Trim

Note: All trim lengths are standard 10'-0"
Lengths up to 26'-0" are Special Order.

Construction Metal Products Inc.
2204 West Front St.
Statesville, NC. 28677

Ph. 1-704-871-8704
Ph. 1-888-750-9827
Fx. 1-704-871-8704

Detail:

Scale:

System: "R" Panel Trim
Date:

Drawing:



CMP

CMP "R" Panel Trim

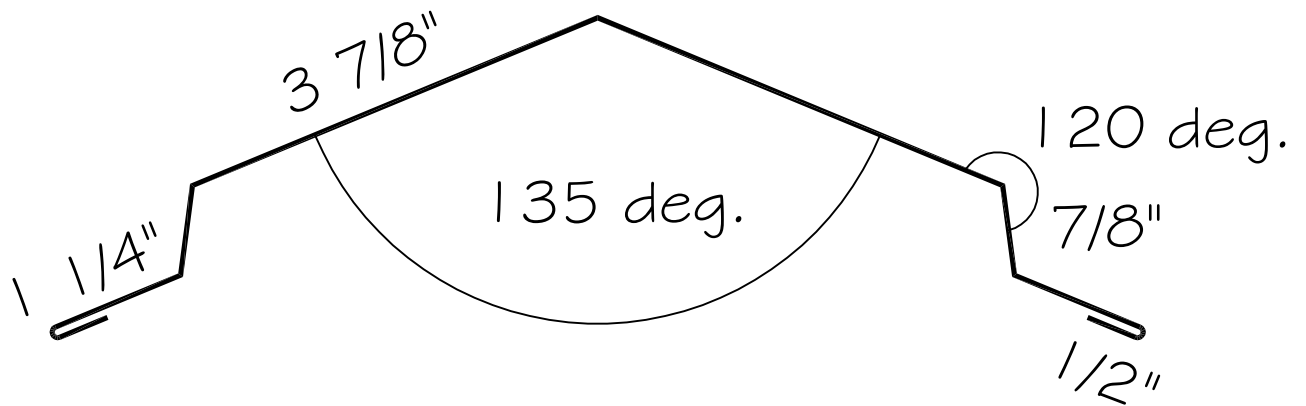

Note: All trim lengths are standard 10'-0"
Lengths up to 26'-0" are Special Order.

Construction Metal Products Inc.
2204 West Front St.
Statesville, NC. 28677

Ph. 1-704-871-8704
Ph. 1-888-750-9827
Fx. 1-704-871-8704

Detail: Stepped Ridge

Scale: n.t.s.

System: "R" Panel
Date:

Drawing: 1

CMP

CMP "R" Panel Trim

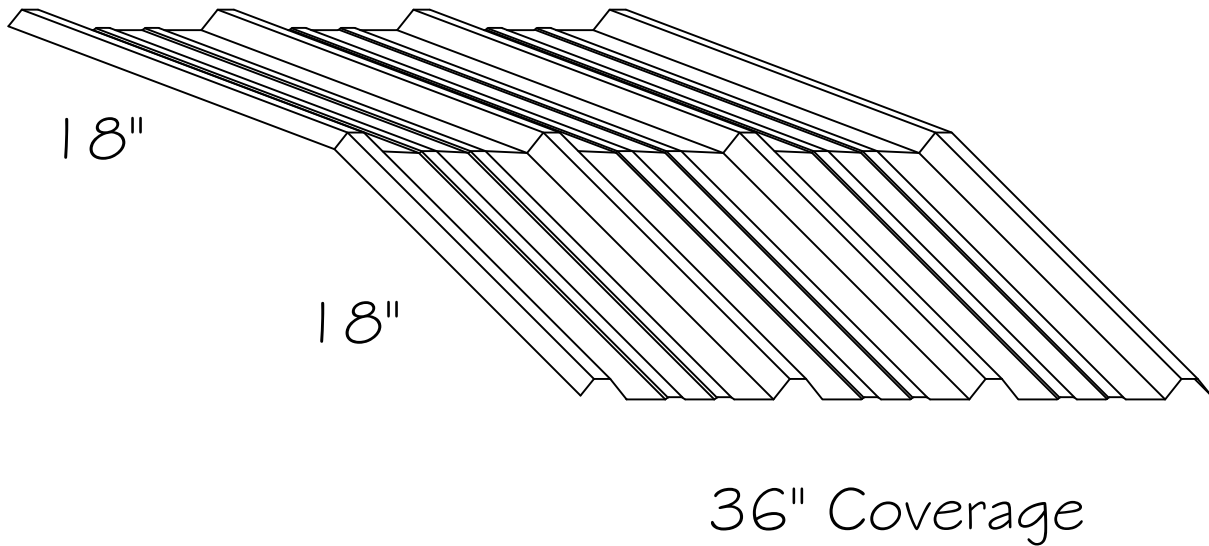

Note: Pitch is to be determined

Construction Metal Products Inc.
2204 West Front St.
Statesville, NC. 28677

Ph. 1-704-871-8704
Ph. 1-888-750-9827
Fx. 1-704-871-8704

Detail: Formed Ridge

System: "R" Panel
Date:

CMP

Scale: n.t.s.

Drawing: 2

CMP "R" Panel Trim

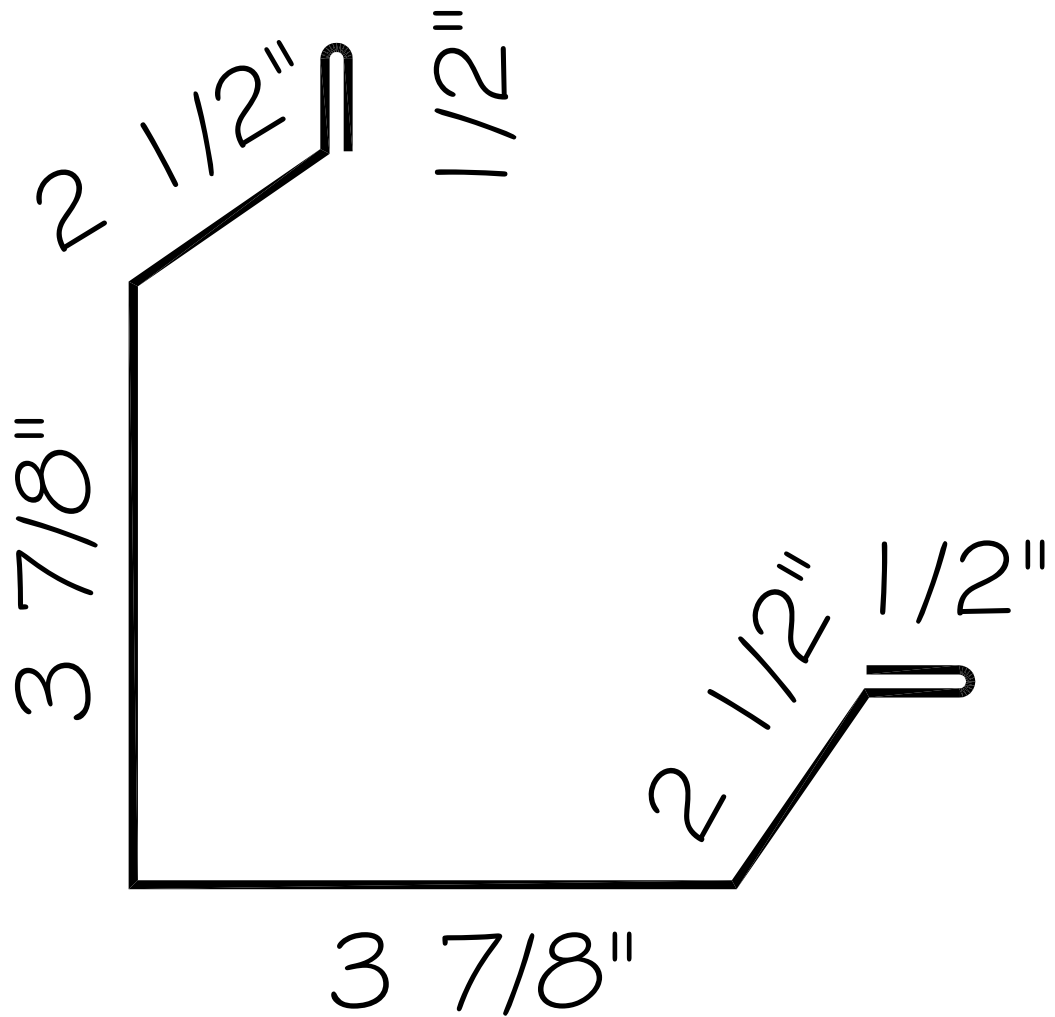

Note: All trim lengths are standard 10'-0"
 Lengths up to 26'-0" are Special Order.

Construction Metal Products Inc.
 2204 West Front St.
 Statesville, NC. 28677

Ph. 1-704-871-8704
 Ph. 1-888-750-9827
 Fx. 1-704-871-8704

Detail: Outside Corner

Scale: n.t.s.

System: "R" Panel Trim

Drawing: 3

Date:

CMP

CMP "R" Panel Trim

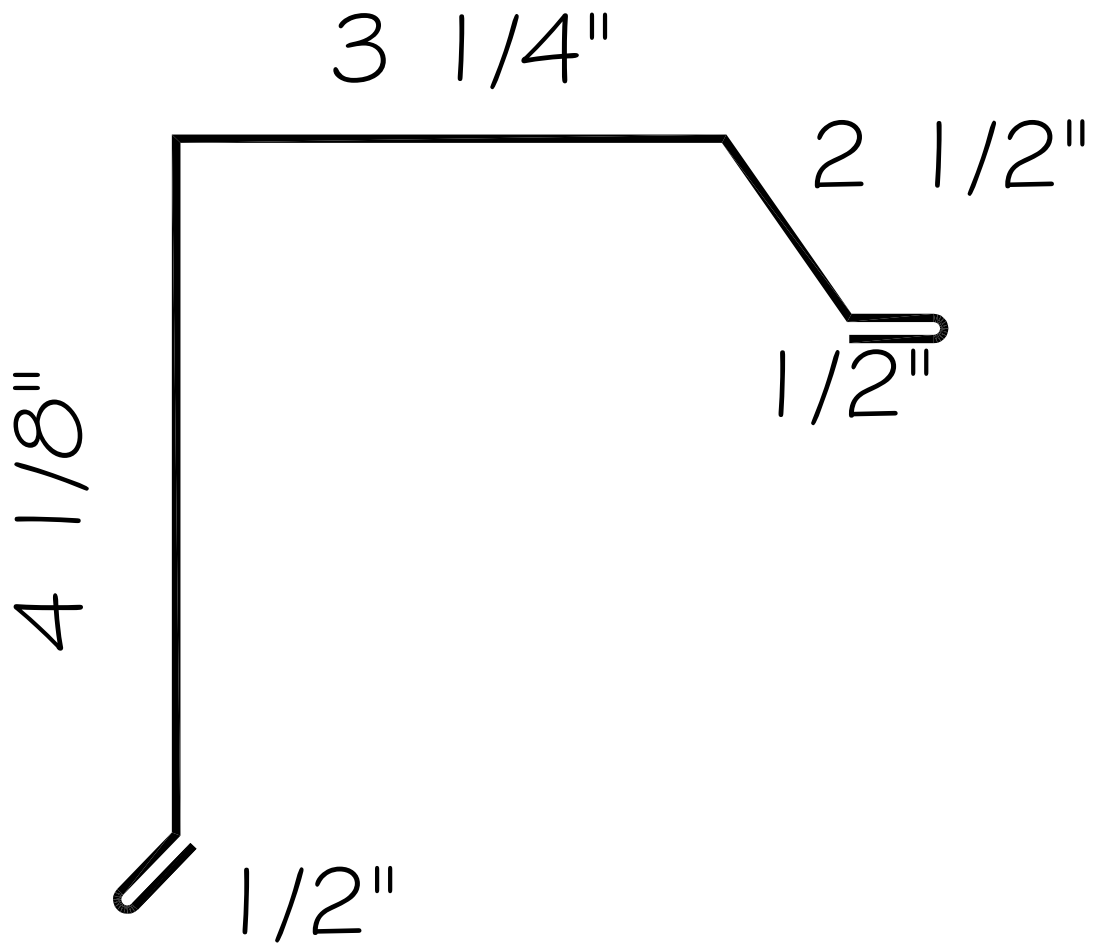

Note: All trim lengths are standard 10'-0"
Lengths up to 26'-0" are Special Order.

Construction Metal Products Inc.
2204 West Front St.
Statesville, NC. 28677

Ph. 1-704-871-8704
Ph. 1-888-750-9827
Fx. 1-704-871-8704

Detail: Gable Trim

System: "R" Panel Trim
Date:

CMP

Scale: n.t.s.

Drawing: 4

CMP "R" Panel Trim

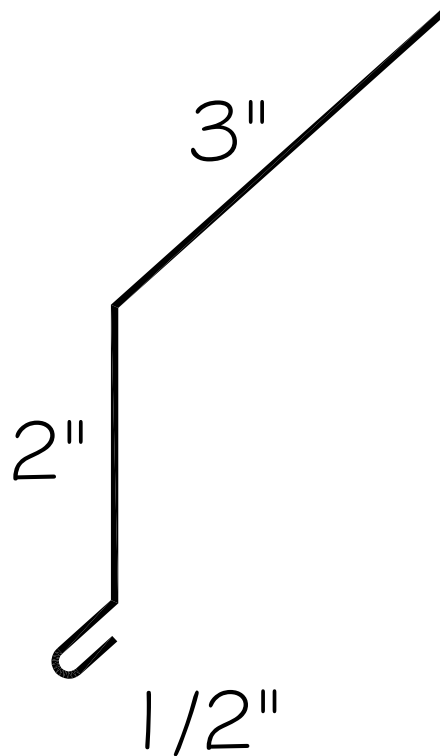

Note: All trim lengths are standard 10'-0"
Lengths up to 26'-0" are Special Order.

Construction Metal Products Inc.
2204 West Front St.
Statesville, NC. 28677

Ph. 1-704-871-8704
Ph. 1-888-750-9827
Fx. 1-704-871-8704

Detail: Drip Trim

System: "R" Panel Trim
Date:

CMP

Scale: n.t.s.

Drawing: 5

CMP "R" Panel Trim

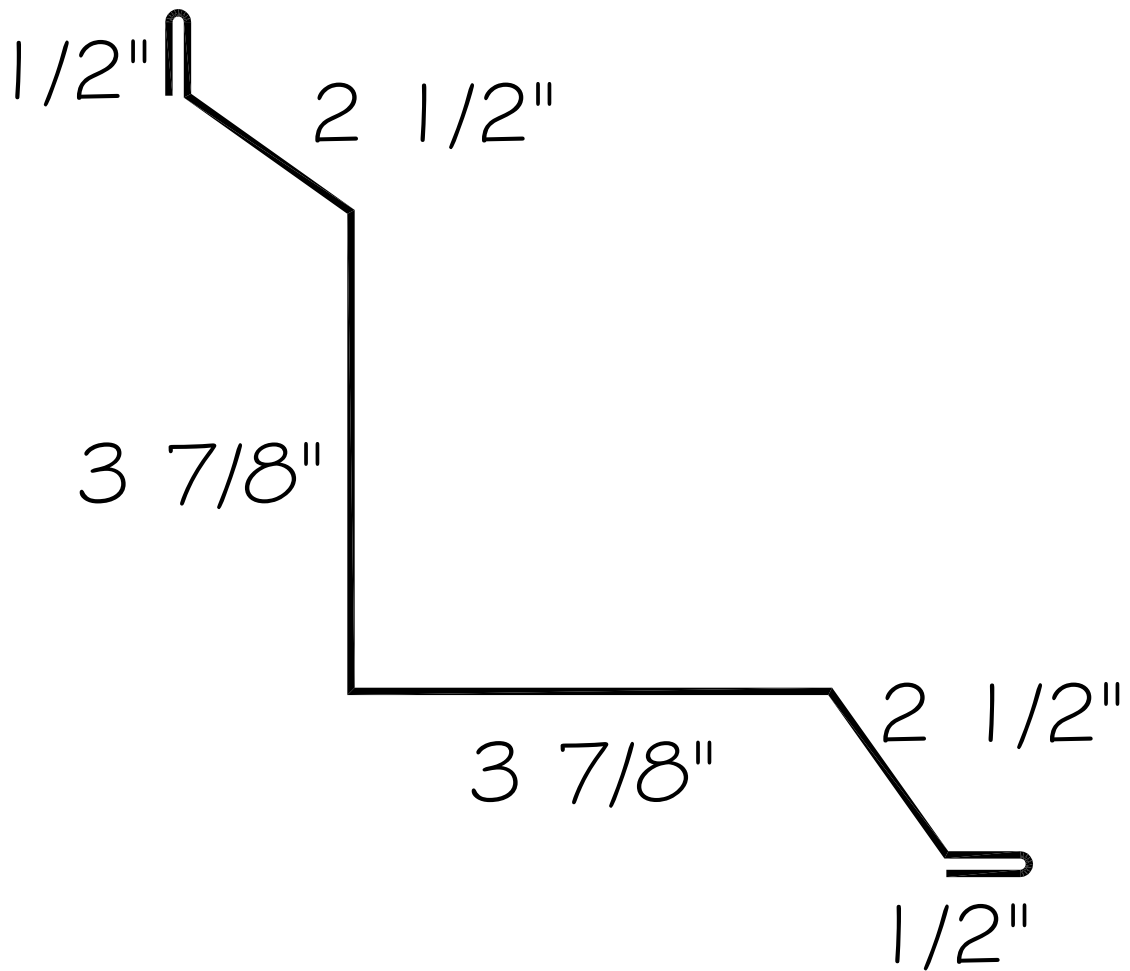

Note: All trim lengths are standard 10'-0"
Lengths up to 26'-0" are Special Order.

Construction Metal Products Inc.
2204 West Front St.
Statesville, NC. 28677

Ph. 1-704-871-8704
Ph. 1-888-750-9827
Fx. 1-704-871-8704

Detail: Inside Corner

System: "R" Panel Trim
Date:

CMP

Scale: n.t.s.

Drawing: 6

CMP "R" Panel Trim

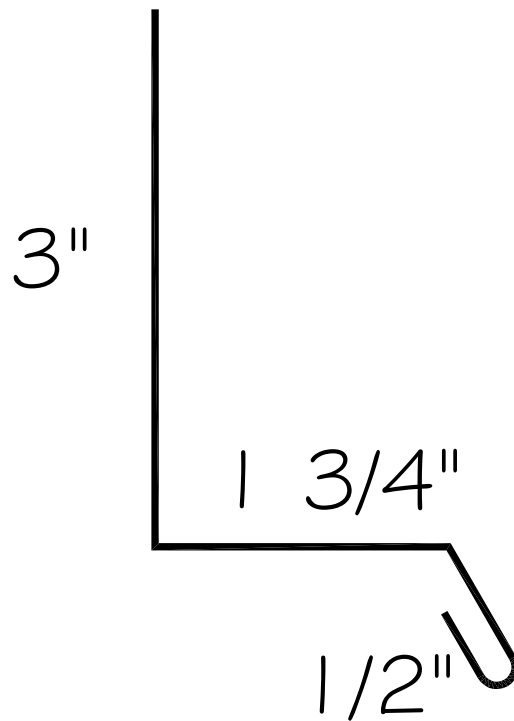

Note: All trim lengths are standard 10'-0"
Lengths up to 26'-0" are Special Order.

Construction Metal Products Inc.
2204 West Front St.
Statesville, NC. 28677

Ph. 1-704-871-8704
Ph. 1-888-750-9827
Fx. 1-704-871-8704

Detail: Base Drip Angle

Scale: n.t.s.

System: "R" Panel Trim
Date:

Drawing: 7

CMP

CMP "R" Panel Trim

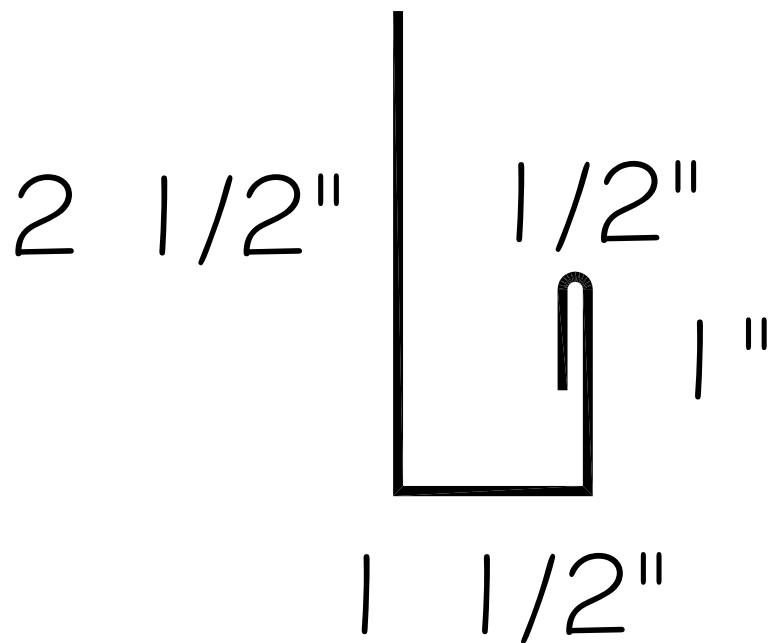

Note: All trim lengths are standard 10'-0"
Lengths up to 26'-0" are Special Order.

Construction Metal Products Inc.
2204 West Front St.
Statesville, NC. 28677

Ph. 1-704-871-8704
Ph. 1-888-750-9827
Fx. 1-704-871-8704

Detail: J-Channel

System: "R" Panel Trim
Date:

CMP

Scale: n.t.s.

Drawing: 8

CMP "R" Panel Trim

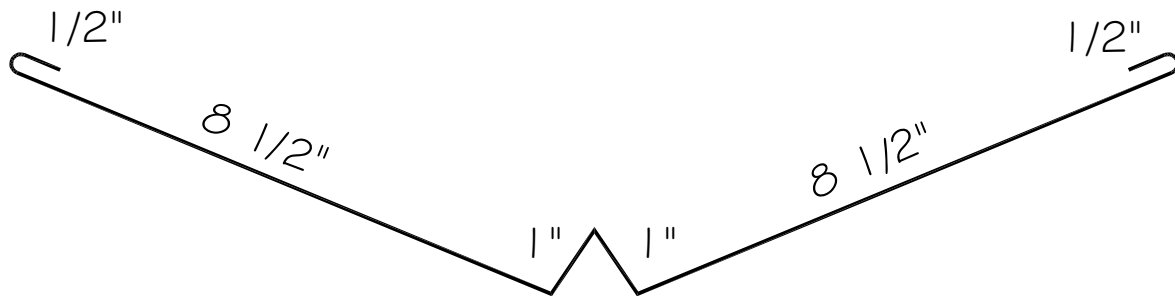

Note: All trim lengths are standard 10'-0"
Lengths up to 26'-0" are Special Order.

Construction Metal Products Inc.
2204 West Front St.
Statesville, NC. 28677

Ph. 1-704-871-8704
Ph. 1-888-750-9827
Fx. 1-704-871-8704

Detail: Valley

System: "R" Panel Trim
Date:

CMP

Scale: n.t.s.

Drawing: 9

CMP "R" Panel Trim

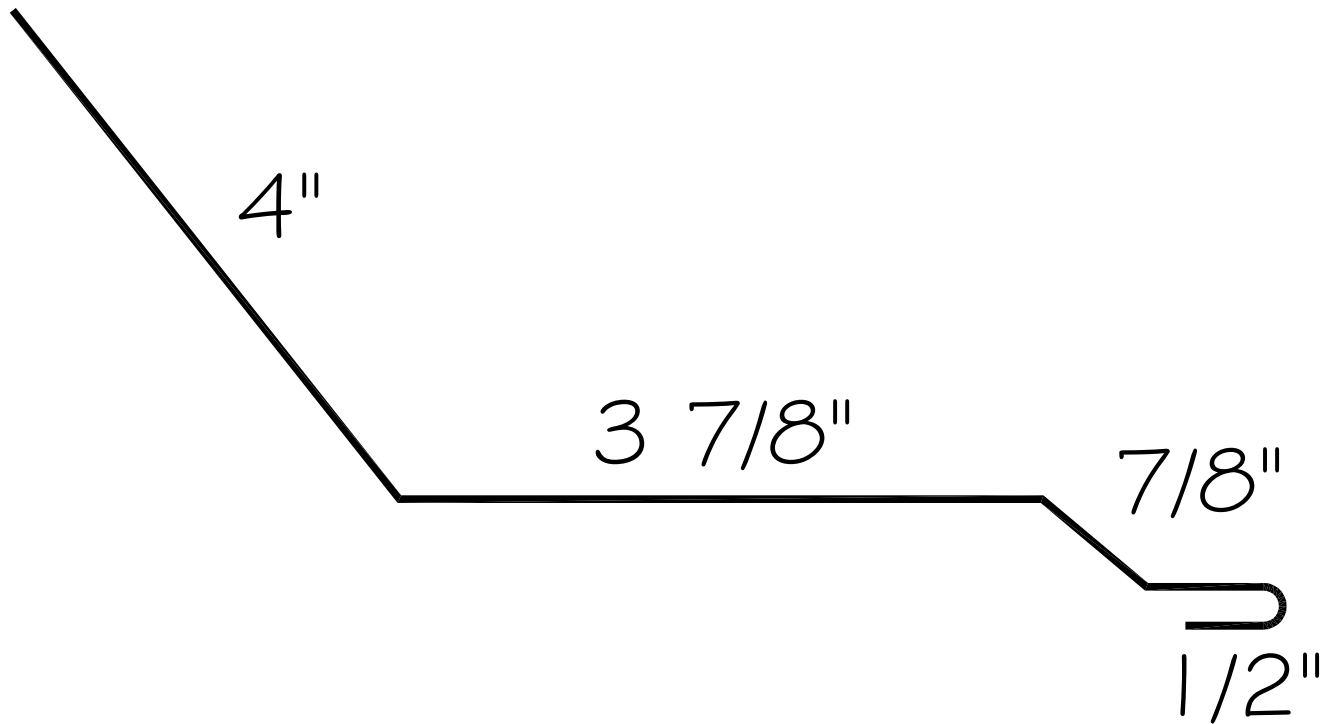

Note: All trim lengths are standard 10'-0"
Lengths up to 26'-0" are Special Order.

Construction Metal Products Inc.
2204 West Front St.
Statesville, NC. 28677

Ph. 1-704-871-8704
Ph. 1-888-750-9827
Fx. 1-704-871-8704

Detail: End Wall Trim

System: "R" Panel Trim
Date:

CMP

Scale: n.t.s.

Drawing: 10

CMP "R" Panel Trim

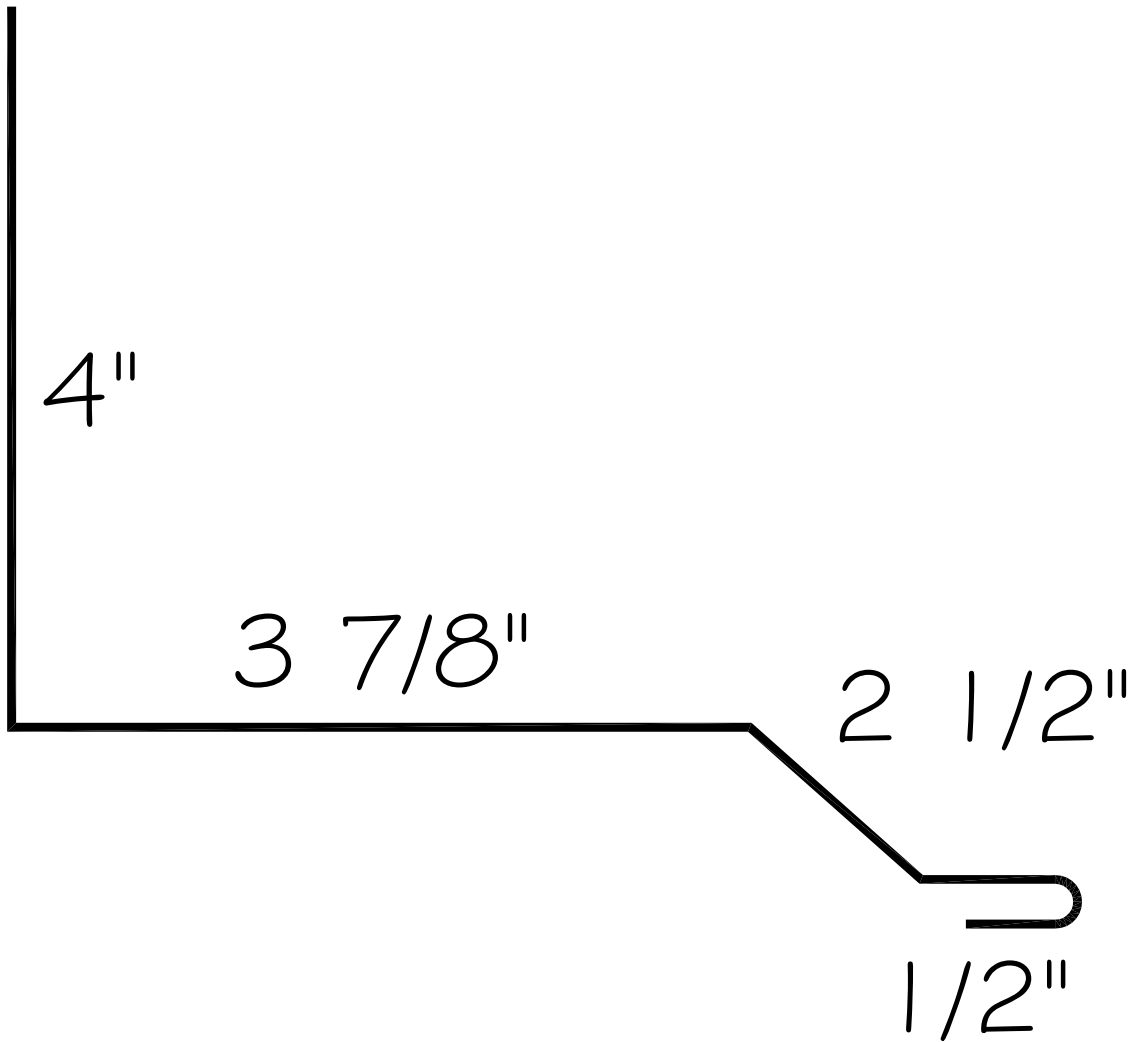

Note: All trim lengths are standard 10'-0"
Lengths up to 26'-0" are Special Order.

Construction Metal Products Inc.
2204 West Front St.
Statesville, NC. 28677

Ph. 1-704-871-8704
Ph. 1-888-750-9827
Fx. 1-704-871-8704

Detail: Side Wall Trim

System: "R" Panel Trim
Date:

CMP

Scale: n.t.s.

Drawing: 11

CMP "R" Panel Trim

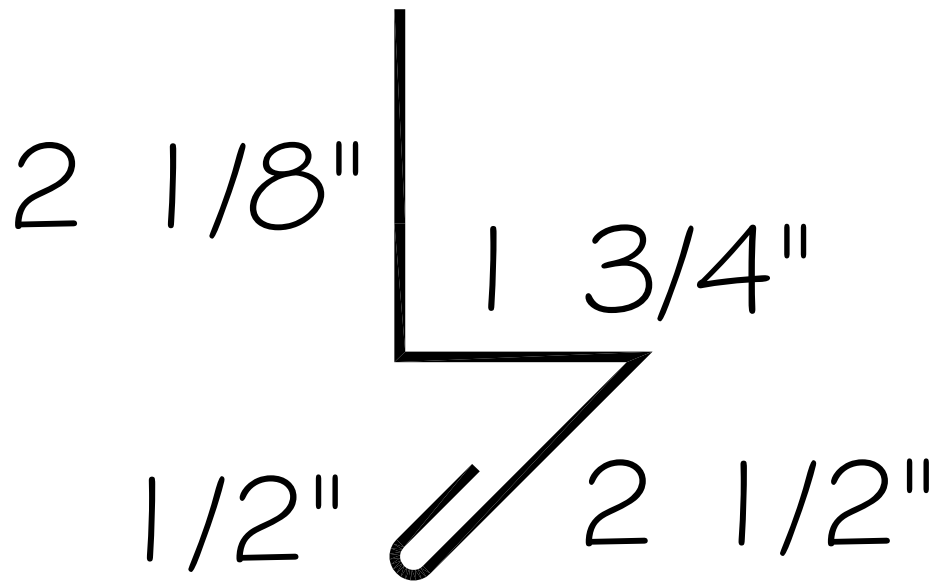

Note: All trim lengths are standard 10'-0"
Lengths up to 26'-0" are Special Order.

Construction Metal Products Inc.
2204 West Front St.
Statesville, NC. 28677

Ph. 1-704-871-8704
Ph. 1-888-750-9827
Fx. 1-704-871-8704

Detail: Base Angle Stop

System: "R" Panel Trim
Date:

CMP

Scale: n.t.s.

Drawing: 12

CMP "R" Panel Trim

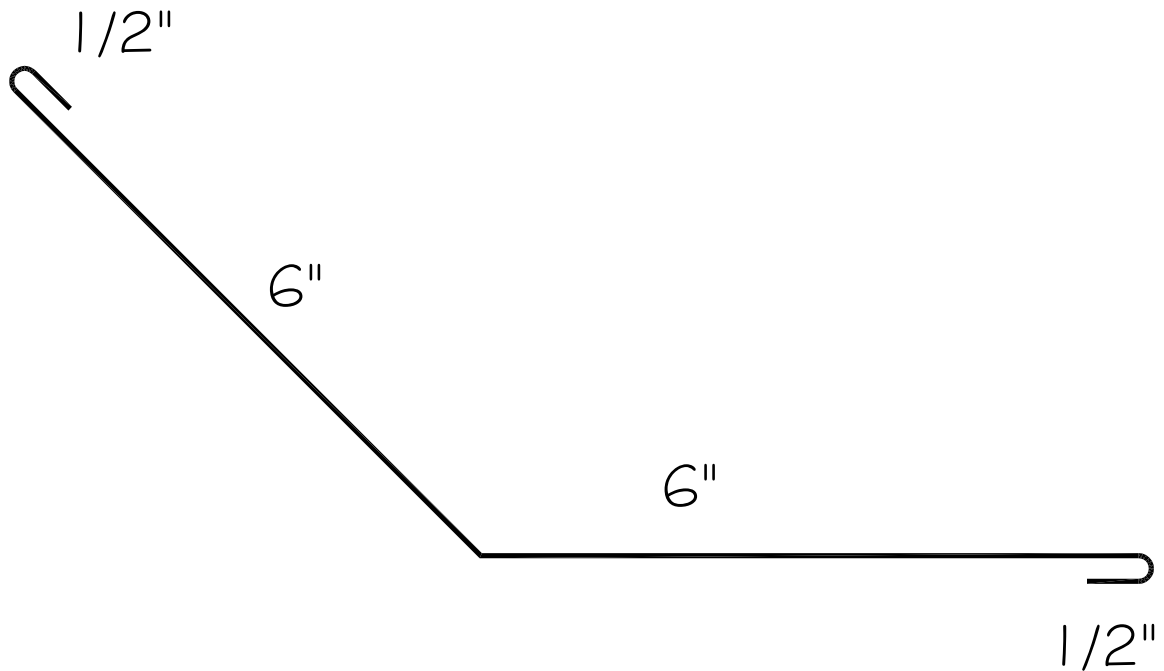

Note: All trim lengths are standard 10'-0"
Lengths up to 26'-0" are Special Order.

Construction Metal Products Inc.
2204 West Front St.
Statesville, NC. 28677

Ph. 1-704-871-8704
Ph. 1-888-750-9827
Fx. 1-704-871-8704

Detail: Transition Trim

System: "R" Panel Trim

Date:

CMP

Scale: n.t.s.

Drawing: 13

CMP "R" Panel Trim

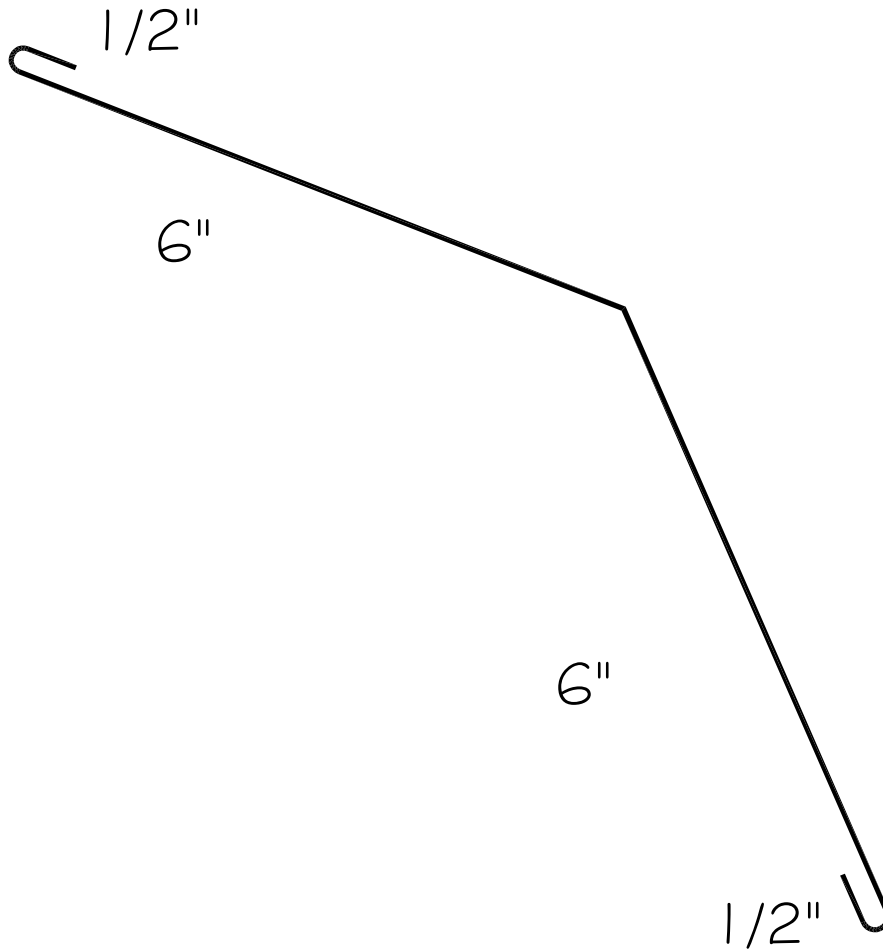

Note: All trim lengths are standard 10'-0"
Lengths up to 26'-0" are Special Order.

Construction Metal Products Inc.
2204 West Front St.
Statesville, NC. 28677

Ph. 1-704-871-8704
Ph. 1-888-750-9827
Fx. 1-704-871-8704

Detail: Gambrel Trim

System: "R" Panel Trim
Date:

CMP

Scale: n.t.s.

Drawing: 14